

INSTRUCTION MANUAL

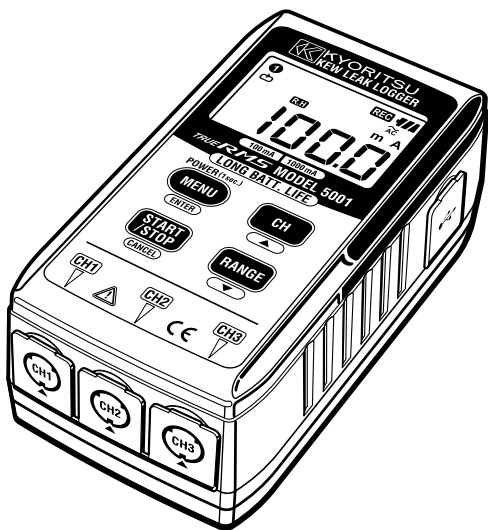

Leak Logger for Measuring & Recording leakage current

KEW LEAK LOGGER

MODEL 5000/5001



**KYORITSU ELECTRICAL INSTRUMENTS
WORKS, LTD.**

Contents

1. Safety warnings	1
2. Features	3
3. Instrument layout.....	4
3-1) Panel	4
3-2) Menu configuration	5
3-3) LCD	7
3-4) Displayed message	8
4. Recording procedures	9
Step1: Preparation	10
Step2: Confirmation and change of set value	11
Step3: Preparation before a recording	12
Step4: Start of recording	14
Step5: Stop of recording	15
5. Recording modes and conditions	16
Continuous recording mode	16
Event recording mode	19
Max value recording mode	21
Capture recording mode	23
6. Recording modes	25
7. Other settings (Setting2)	30
8. Data transfer to PC	35
9. Battery replacement	37
10. Specification	38



1. Safety Warnings

This instrument has been designed, manufactured and tested according to IEC 61010: Safety requirements for Electronic Measuring apparatus, and delivered in the best condition after passed the inspection. This instruction manual contains warnings and safety rules which must be observed by the user to ensure safe operation of the instrument and retain it in safe condition. Therefore, read through these operating instructions before using the instrument.

WARNING

- Read through and understand the instructions contained in this manual before starting to use the instrument.
- Save and keep the manual at hand to enable quick reference whenever necessary.
- Be sure to use the instrument only in its intended applications.
- Be sure to understand and follow all safety instructions contained in the manual.

Be sure to observe the above instructions. Failure to follow the above instructions may cause injury, instrument damage and/or damage to equipment under test.

The symbol  indicated on the instrument means that the user must refer to related parts in the manual for safe operation of the instrument. Be sure to carefully read the instructions following each  symbol in the manual.

 **DANGER** is reserved for conditions and actions that are likely to cause serious or fatal injury.

 **WARNING** is reserved for conditions and actions that can cause serious or fatal injury.

 **CAUTION** is reserved for conditions and actions that can cause a minor injury or instrument damage.

DANGER

- Never make measurement on the circuit in which voltage over AC300V exists.
- Do not attempt to make measurement in the presence of flammable gasses.
Otherwise, the use of the instrument may cause sparking, which can lead to an explosion.
- Transformer jaw tips are designed not to short the circuit under test. If equipment under test has exposed conductive parts, however, extra precaution should be taken to minimize the possibility of shorting.
- Never attempt to use the instrument if its surface or your hand is wet.
- Do not exceed the maximum allowable input of any measuring range.
- Never open the Battery cover during a measurement.
- Verify proper operation on a known source before use or taking action as a result of the indication of the device.

WARNING

- Never attempt to make measurement if any abnormal conditions, such as broken case and exposed metal parts are found on the instrument.
- Do not install substitute parts or make any modification to the instrument.
For repair or re-calibration, return the instrument to your local KEW distributor from where it was purchased.
- Do not try to replace the batteries if the surface of the instrument is wet.
- Make sure to remove the input clamps, and power off the instrument when opening the Battery cover for battery replacement.

CAUTION

- Do not expose the instrument to the direct sun, high temperature and humidity or dewfall.
- Be sure to power off the instrument after use. When the instrument will not be in use for a long period, place it in storage after removing the batteries.
- Use a cloth dipped in water or neutral detergent for cleaning the instrument.
Do not use abrasives or solvents.

2. Features

- This instrument is a leak logger for measuring and recording leakage current.
- Capable of recording leakage current from 1 to 3ch with leakage clamp sensor. (Leak clamp sensors: M-8141/8142/8143 are available.)
- Can measure and record max. AC1000mA(50/60Hz) with RMS.
- LED current indicator flashes when the preset current value is exceeded. (Event/ Max. value/ Capture recording mode)
- Can store 60,000 data when using 1ch, and when using all 3ch, can store 20,000 data at each channel. (Continuous recording mode)
- Data will not be lost at battery replacement or at lower battery voltage as it is stored in nonvolatile memory.
- Can perform recording for long time with Power-save function.
- Can transfer the recorded data to PC via USB cable.
- Protected throughout by double (reinforced) insulation "□".
- This instrument provides 4 recording modes. Can be used for any kinds of insulation controls since the user can select any desirable recording mode as usage. Read through the instruction manual and understand the features of each recording mode to select the appropriate recording mode.

3. Instrument layout

3-1) Panel

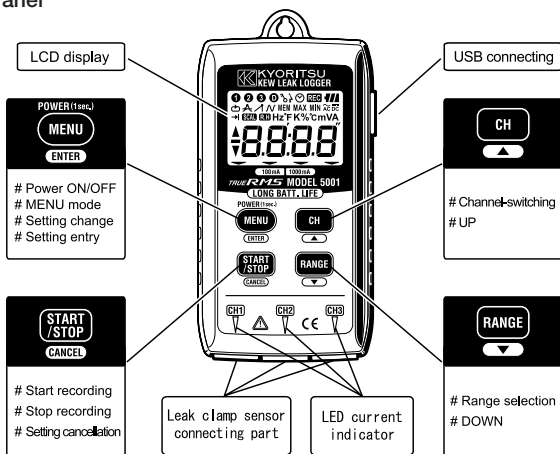

● Operation of button

Button	At recording / measurement mode:	At menu mode:
	Shift to Menu mode	Select Menu, Setting change, Enter
	Start and stop recording	Back, Cancel
	Switch channels	Switch Menu item, Increase number
	Switch ranges	Switch Menu item, Decrease number

- LCD . . . P. 7
- LED current indicator . . . P.18
- USB . . . P.35

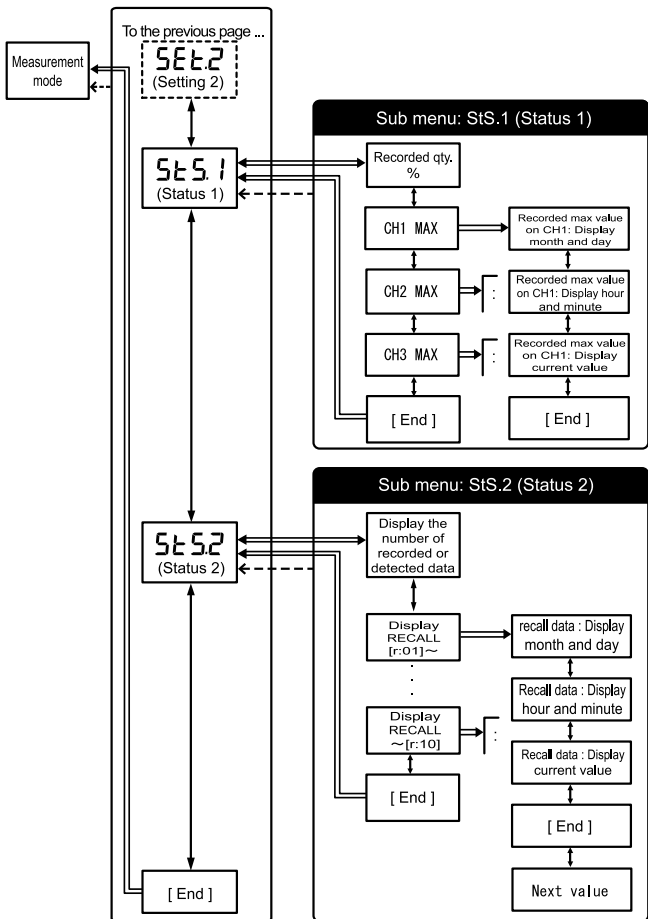

3-1) LCD

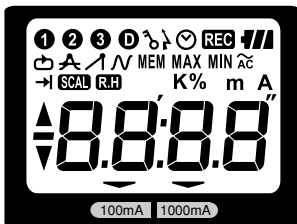

Mark	Details
1 2 3	Selected channel number (The measured value at this channel is displayed.)
	Auto-power-off is disabled. (Instrument won't be off automatically.)
	Timer function is activated. (Stand-by till the preset time.)
REC	Recording
	Battery mark
	Recording mode
MEM	Displayed when viewing the recorded data.
MAX MIN	Displayed when viewing the recorded max. and min. value.
	One-time system is activated. (Recording stops when memory becomes full.)
SCAL	Scale function is activated. (("Measured result" x "Scale value" is displayed.)
R.H	Range hold (Not displayed at auto-ranging.)
	Menu guide (▲/▼button can be operated.)
	Measurement range (100.0mA/1000mA)

3-4) Displayed message

Message	Meaning
NC	Sensor is not connected.
OL	Over-range
SET.1	Menu: Setting1(SET.1) View or change the recording mode/ condition.
SET.2	Menu: Setting2(SET.2) View or change the Location information and auto-power-off function.
STS.1	Menu: Status 1(STS.1) View the recorded quantity and the max. value at each channel.
STS.2	Menu: Status 2(STS.2) View the number of recorded data and RECALL.
End	Menu: End
LOG	Continuous recording mode (LOGging)
dtc	Event recording mode (detect)
-	Max. value recording mode (Max)
CAP	Capture recording mode (CAPture)
-PC-	PC data in transit
CLr	Warning of memory clear

4. Recording procedures

Following explains the flow of operation: through preparation to the stop of recording.

P. 10

Step1: Preparation

- ▼ Select the appropriate sensor, and connect it to the instrument.

P. 11

Step2: Confirmation and change of set value

- ▼ Confirm the recording mode.

P. 12

Step3: Preparation before a recording

- ▼ Install the instrument and do setups for each channel.

P. 14

Step4: Start of recording

- ▼ Start recording.

P. 15

Step5: Stop of recording

Stop recording.

* The recorded data can be viewed either by the following two methods.

(1) On a PC: Refer to "8. Data transfer to PC" in this manual. (P.35)

(2) On the instrument: Refer to **(2)Confirmation of recorded data (status 1)**
(3)Confirmation of recorded data (status 2) described in the supplied Quick manual.

* Press the  button at least 1 sec. to power off the instrument.

Step1: Preparation

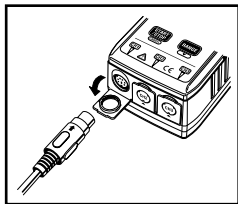

1. Connect the clamp sensor to the instrument firmly with careful attention to the orientation of the connector.

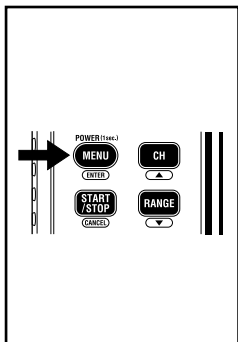

2. Press the **MENU** button at least 1 sec. to power on the instrument. Release the button when all indications are displayed on the LCD.
3. Time is displayed on the LCD for 1 sec. If incorrect time is displayed each time when the instrument is powered on, battery for the clock may be exhausted. In this case, send back the instrument to your local KEW distributor from where it was purchased.

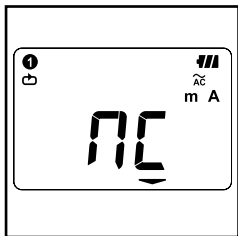





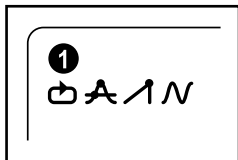



4. Can make measurement right after powering on the instrument. When **AC** (non-connect) is displayed on the LCD, a sensor is not connected to the appropriate channel; or the connection is incorrect.

Step2: Confirmation and change of set value



Confirm the mark indicating the selected recording mode.

Refer to "5. Recording modes and conditions" in this manual to change the recording mode or condition (Recording interval/ Preset current value).

Recording mode	Details	Refer to:
Continuous recording  	Intermittent measured value is recorded continuously at the preset interval. (15-kind: 1 sec. to 60 min.)	P.16
Event recording  	When the preset current value is exceeded , (hereinafter, this event is referred as current detection) three previous RMS value, the RMS value when detecting it, and four subsequent RMS values, 8 data in total (0.8 sec.) are recorded.	P.19
Max. value Recording  	The max. RMS value is recorded at every 10 sec. prior to and subsequent to the current detection. It ends when a value drops to 50% or less of the preset current value; or when 10 min. has been elapsed.	P.21
Capture recording  	Ten to twelve waveforms (for 200mS) are recorded prior to and subsequent to the current detection.	P.23

Step3: Preparation before a recording

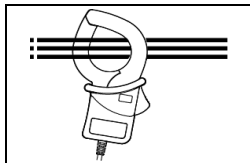

1. Clamp on the measured object and fix the Clamp sensor.

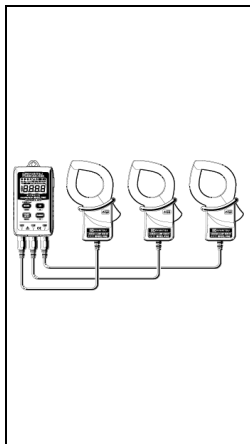

2. Instrument shall be firmly fixed so as not to come off easily.
 - 1) Hang the instrument on hook:
Can fix the instrument with a hook or screw by using the hooking hole on the top of the instrument.
 - 2) Fix the instrument with magnet on its back. Can fix the instrument to metallic plate with the magnet on its backside.

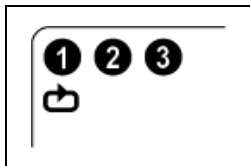

3. Press the **CH** button to switch the display of measured value among Channel (1) and (3).

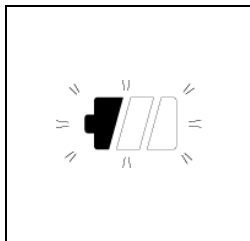
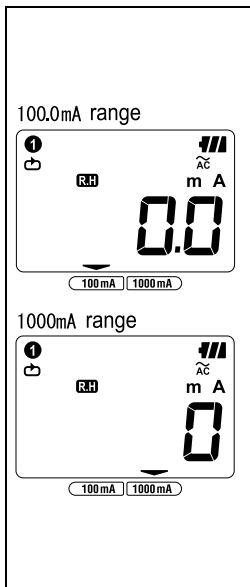

4. Press the **RANGE** button to switch the measurement ranges at each channel. The Range hold function is activated when the **R.H** mark is displayed on the LCD.

Note

- At continuous recording mode:
It switches in the sequence below.
Auto-ranging → 1000mA → 100.0mA → Auto-ranging
- At Event/ Max. value/ Capture recording mode:
It switches between 1000mA and 100.0mA.
Range cannot be switched during a recording. Select the appropriate range before a recording.

5. When only the leftmost segment of the Battery mark is flashing on the LCD, it means battery voltage is low. Replace the batteries with new ones. When nothing is displayed on the LCD, the batteries are exhausted. Replace the batteries with new ones.

Step4: Start of recording

Follow the procedures stated below and start recording.

Be sure to check each setting before starting a recording since the settings cannot be changed during a recording.

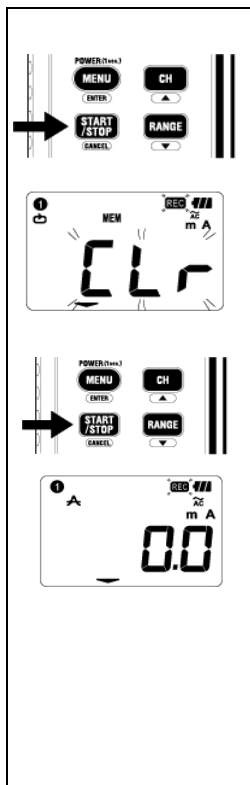

1. Press down the **START/STOP** button for a while.
 - At continuous recording mode or after changing the recording mode; "CLr" flashes while the button is being pressed down. A few seconds later, the measured value and the "REC" mark are displayed on the LCD. Then a recording starts.
(The data, which had been recorded, will be cleared at this time. So the important data must be transferred to PC in advance.)
 - At Event/ Max value/ Capture recording mode or the recording mode is not changed, the "REC" mark flashes and the measured value and the "REC" mark are displayed on the LCD. Then a recording starts.
(At these recording modes, recorded data will not be cleared when continuous recording is performed. The recorded data will be deleted when changing a recording mode or sensor connecting channel. So the important data must be transferred to PC in advance.)

Following operations are available during a recording.

- * Display the measured value at each channel **CH** button
- * Recording state: Display the max. recorded value
→Refer to **(2) Confirmation of recorded data (status 1)** described in the supplied Quick manual.
- * Recording state: Display RECALL
→Refer to **(3) Confirmation of recorded data (status 2)** described in the supplied Quick manual.
- * Confirm the setting value at Setting1 "SEt.1" and Setting2 "SEt.2".

Following operations are NOT available during a recording.

- * Power off the instrument.
 - * Switch measurement ranges.
 - * Change the setting value at Setting1 "SEt.1" and Setting2 "SEt.2".
 - * Communication with PC
- Stop the recording once to do above operations.

Step5: Stop of recording

The recording ends automatically when One-time system has been set to "ON" at "Step2: Confirmation and change of the set value".

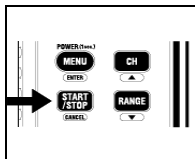

1. Press the **START/STOP** button at least 1 sec. to stop the recording.
2. Recording stops, and the "REC" mark disappears. Then the instrument goes back into measurement state.

Now recording is complete.

- * Press the **MENU** button at least 1 sec. to power off the instrument.

5. Recording modes and conditions



Continuous recording mode: Recording interval of 1min.

Max. number of recorded data

Using all 3 channels	Using 2 channels	Using only 1 channel
20,000 data	40,000 data	60,000 data

Max. recording duration

Recording interval	Using all 3 channels	Recording interval	Using all 3 channels
1sec.	5:33:20	1min.	13 days/ 21:20:00
2sec.	11:06:40	2min.	27 days/ 18:40:00
5sec.	1 day/ 3:46:40	5min.	69 days/ 10:40:00
10sec.	2 days/ 7:33:20	10min.	138 days/ 21:20:00
15sec.	3 days/ 11:20:00	15min.	208 days/ 8:00:00
20sec.	4 days/ 15:06:40	20min.	277 days/ 18:40:00
30sec.	6 days/ 22:40:00	30min.	416 days/ 16:00:00
		60min.	833 days/ 8:00:00

Note) * Max. recoding duration is limited by the battery life.

* Max. recording duration is lengthened by 1.5 times when using 2 channels, and tripled when using 1 channel only.

Setting procedure

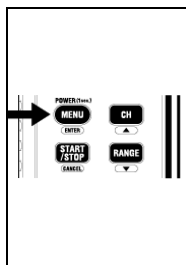

1. Power on the instrument, and press the **MENU** button. Then the instrument goes into Menu mode.

Each button acts as follows at Menu mode.

- MENU** → **ENTER** : Select, Change, Enter
- START/STOP** → **CANCEL** : Return, Cancel
- CH** → **▲** : Switch, Increase set value
- RANGE** → **▼** : Switch, Decrease set value

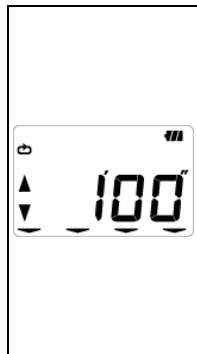
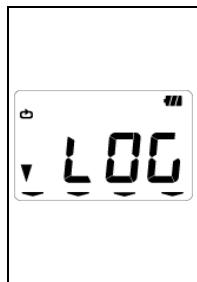
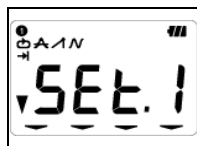

2. Press the **(ENTER)** button when "SEt.1" is displayed on the LCD.

3. The selected recording mode is displayed. When **(LOG)** (Continuous recording mode) is displayed on the LCD, press the **(▼)** button to proceed to the next setting.

In case that **(dEc)**, **(-_-)** or **(CAP)** is displayed on the LCD, press the **(ENTER)** button.

Then the indication on the LCD flashes. Press the **(▲)** or **(▼)** button to change it to **(LOG)**. Press the **(ENTER)** button.

4. The recording interval is displayed.

Can be selected from; 1, 2, 5, 10, 15, 20, 30 sec., 1, 2, 5, 10, 15, 20, 30, 60 min
--

- Press the **(▼)** button and proceed to the next step when not changing the setting.
- To change the setting, press the **(ENTER)** button.

Then the indication on the LCD flashes. Press the **(▲)** or **(▼)** button to set the value to the desired one. Then press the **(ENTER)** button to confirm it.

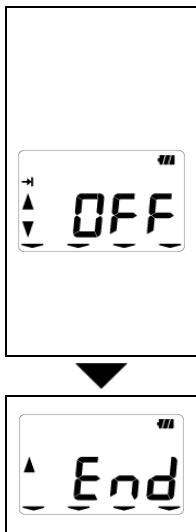

5. State of One-time system is displayed.

on: Recording stops when memory becomes full.

off: Overwrite the old data, and store the latest data.

- Press the button and proceed to the next step when not changing the setting.

- To change the setting, press the button.

Then the indication on the LCD flashes. Press the or button to set the value to the desired one. Then press the button to confirm it.

6. Now Setting 1 is complete; "End" is displayed on the LCD. Press the button to return to the screen on which "SEt.1" is displayed.

7. Press the button to get the instrument ready for a measurement.

LED current indicator

* At the Event/ Max. value/ Capture recording modes, when the preset current value is exceeded, the corresponding LED for each channel flashes. The LED flashes each time when the preset current value is exceeded during a measurement. The LED keep flashing once the event that exceeds the preset current value occurs during a recording. Press the button once to restore the flashing LED.

When the button is pressed, the instrument goes into Menu mode. Then press the button. LED flashes when the preset current value is exceeded again. Press the button to return to the measurement screen; after the indications disappeared because of Power-save function. In this case, the LED is turned off temporary . Press the button and button again to turn off the LED completely.



Event recording mode: Current set value of 15mA

Max. number of recorded data

Using all 3 channels	Using 2 channels	Using only 1 channel
1,600 data	2,400 data	4,800 data

Setting procedure

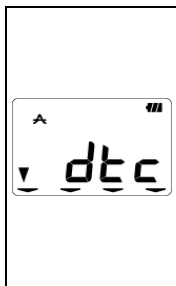
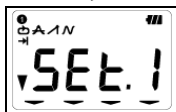
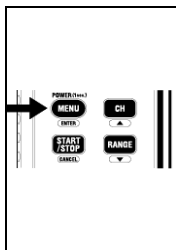

1. Power on the instrument, and press the **MENU** button.

Then the instrument goes into Menu mode. Each button acts as follows at Menu mode.

MENU	→	ENTER	: Select, Change, Enter
START/STOP	→	CANCEL	: Return, Cancel
CH	→	▲	: Switch, Increase set value
RANGE	→	▼	: Switch, Decrease set value

2. Press the **ENTER** button when "SET.1" is displayed on the LCD.

3. The selected recording mode is displayed. When **dte** (Event recording mode) is displayed on the LCD, press the **▼** button to proceed to the next setting. In case that **LOG**, **-** or **CAP** is displayed on the LCD, press the **ENTER** button.

Then the indication on the LCD flashes. Press the **▲** or **▼** button to change it to **dte**. Press the **ENTER** button.

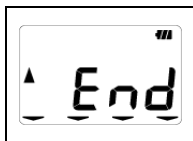
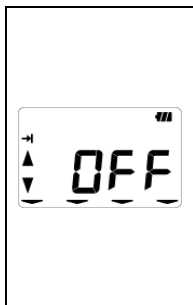
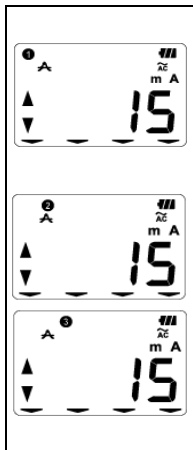

4. Pre-set current value at channel 1 is displayed.

Can be set at every 1mA from 0 to 1000mA

- Press the button and proceed to the next step when not changing the setting.
- To change the setting, press the button. Then the indication on the LCD flashes. Press the or button to set the value to the desired one. Then press the button to confirm it.

Note After 1 data is recorded, current will not be detected until current drops to 50% or less of the preset current value as the last detected leakage current is remaining. Please set it to the appropriate value with reference to the measurement performed before starting a recording.

5. Confirm or change the preset current value on channel 2 and 3 as well.

6. State of One-time system is displayed.

on: Recording stops when memory becomes full.

off: Overwrite the old data, and store the latest data.

- Press the button and proceed to the next step when not changing the setting.
- To change the setting, press the button. Then the indication on the LCD flashes. Press the or button to set the value to the desired one. Then press the button to confirm it.

7. Now Setting 1 is complete; "End" is displayed on the LCD. Press the button to return to the screen on which "SEt.1" is displayed.

8. Press the button to get the instrument ready for a measurement.



Max. value recording mode: Current set value of 15mA

Max. number of recorded data

Using all 3 channels	Using 2 channels	Using only 1 channel
330 data	495 data	990 data

Setting procedure

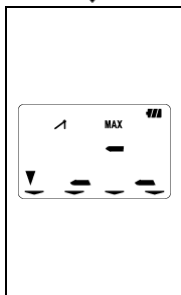
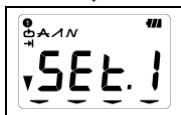
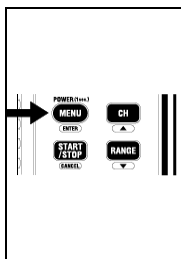

1. Power on the instrument, and press the **MENU** button.

Then the instrument goes into Menu mode. Each button acts as follows at Menu mode.

MENU	→	ENTER	: Select, Change, Enter
START/STOP	→	CANCEL	: Return, Cancel
CH	→	▲	: Switch, Increase set value
RANGE	→	▼	: Switch, Decrease set value

2. Press the **ENTER** button when "SEt.1" is displayed on the LCD.

3. The selected recording mode is displayed. When **MAX** (Max. value recording mode) is displayed on the LCD, press the **▼** button to proceed to the next setting. In case that **LOG**, **dEc** or **CAP** is displayed on the LCD, press the **ENTER** button. Then the indication on the LCD flashes. Press the **▲** or **▼** button to change it to **MAX**. Press the **ENTER** button.

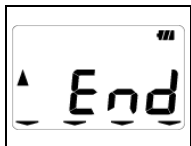
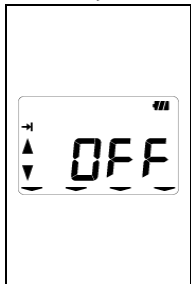
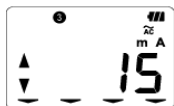
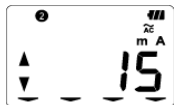
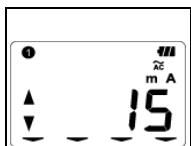

4. Pre-set current value on channel 1 is displayed.

Can be set at every 1mA from 0 to 1000mA.

- Press the button and proceed to the next step when not changing the setting.
- To change the setting, press the button.

Then the indication on the LCD flashes. Press the or button to set the value the desired one). Then press the button to confirm it.

Note After 1 data is recorded, current will not be detected until current drops to 50% or less of the preset current value as the last detected leakage current is remaining. Please set it to the appropriate value with reference to the measurement performed before starting a recording.

5. Confirm or change the preset current value at channel 2 and 3 as well.

6. State of One-time system is displayed.

on: Recording stops when memory becomes full
off: Overwrite the old data, and store the latest data.

- Press the button and proceed to the next step when not changing the setting.
- To change the setting, press the button.

Then the indication on the LCD flashes. Press the or button to set the value to the desired one. Then press the button to confirm it.

7. Now Setting 2 is complete; "End" is displayed on the LCD. Press the button to return to the screen on which "SEt.2" is displayed.

8. Press the button to get the instrument ready for a measurement.

Max. number of recorded data

Using only 1 channel

345 data

Setting procedure

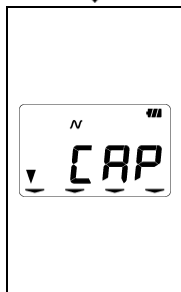
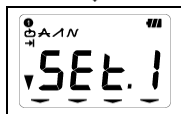
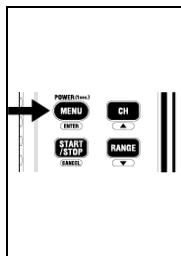

1. Power on the instrument, and press the **MENU** button.

Then the instrument goes into Menu mode. Each button acts as follows at Menu mode.

- | | | | |
|-------------------|---|---------------|------------------------------|
| MENU | → | ENTER | : Select, Change, Enter |
| START/STOP | → | CANCEL | : Return, Cancel |
| CH | → | ▲ | : Switch, Increase set value |
| RANGE | → | ▼ | : Switch, Decrease set value |

2. Press the **ENTER** button when "SEt.1" is displayed on the LCD.

3. The selected recording mode is displayed. When **CAP** (Capture recording mode) is displayed on the LCD, press the **▼** button to proceed to the next setting. In case that **LOG**, **dtc** or **-** is displayed on the LCD, press the **ENTER** button.

Then the indication on the LCD flashes. Press the **▲** or **▼** button to change it to **CAP**. Press the **ENTER** button.

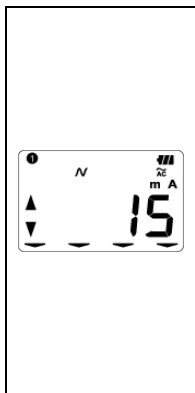

4. Pre-set current value on channel 1 is displayed.

Can be set at every 1mA from 0 to 1000mA.

- Press the button and proceed to the next step when not changing the setting.
- To change the setting, press the button.

Then the indication on the LCD flashes. Press the or button to set the value the desired one). Then press the button to confirm it.

Note After 1 data is recorded, current will not be detected until current drops to 50% or less of the preset current value. Please set it to the appropriate value with reference to the measurement performed before starting a recording.

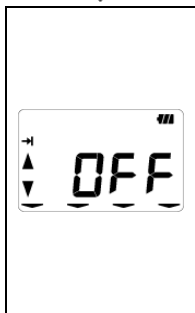

5. State of One-time system is displayed.

on: Recording stops when memory becomes full
 off: Overwrite the old data, and store the latest data.

- Press the button and proceed to the next step when not changing the setting.
- To change the setting, press the button.

Then the indication on the LCD flashes. Press the or button to set the value to the desired one. Then press the button to confirm it.

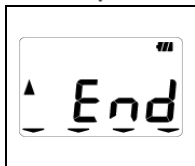



6. Now Setting 1 is complete; "End" is displayed on the LCD. Press the button to return to the screen on which "Set.1" is displayed.

7. Press the button to get the instrument ready for a measurement.

6. Recording modes

List of recording modes

Recording mode	Continuous recording	Event recording	Max. value recording	Capture recording
				
Details	P.26	P.27	P.28	P.29
To check:	Condition, Intermittent leakage	Occurrence of leakage	Intermittent leakage, Occurrence of leakage	Waveform
Can record:	60,000 data(1ch) 20,000 data(3ch)	4,800 data(1ch) 1,600 data(3ch)	990 data(1ch) 330 data(3ch)	345 data
Available CH	3 channels at the same time			CH1 only
Recording interval	15-kind: 1 sec. to 60 min.	----		
Pre-set current value	----	0~1000mA (can be set at every 1mA)		
Measurement interval	Pre-set recording interval (intermittent measurement)	Approx. 0.1 sec. (constant)		
Sampling cycle	At 50Hz: approx. 0.222mS At 60Hz: approx. 0.185mS	Current detection: approx. 1.67mS RMS: approx. 3.33mS	Current detection: approx. 0.56mS RMS:approx. 1.11mS	
Sampling period	For 2 cycles (50Hz: for 40mS)	Constantly until current detection		
Record timing	At every recording interval	When the pre-set current value is exceeded. (irregular)		
Measuring method	True RMS	Current detection: Average value (Convert the Peak value (sine) to RMS) Record/Display: True RMS		
One-time system	ON : Recording stops when memory becomes full. OFF: Overwrite the old data, and store the latest data.			
Battery life	Approx. 25 days (M-5000)/ Approx. 40 days (M-5001)			

(1) Continuous recording mode

- Sampling period and RMS calculation

The input signal obtained via the connected sensor is sampled (at 50Hz, approx 0.222mS; at 60Hz, approx. 0.185mS) just for 2-cycle (180 data). Then RMS value is calculated by the sampled 180 data. The instrument goes into stand-by mode till next recording interval comes.

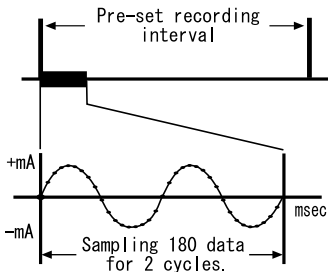

- Recording

The channels to which each sensor is being connected are switched in sequence at recording interval. Then RMS values are found by sampling the data for 2-cycle at each channel and recorded.

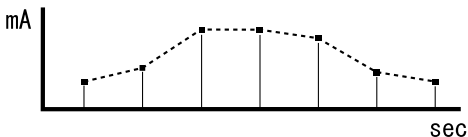

- Display of measured value

At measurement state before a recording, the measured value is displayed on the LCD at every 1 sec..

(2) **A** Event recording mode

- Current detection and RMS calculation

Sampling is performed consistently at 1.6ms intervals. Current is detected by comparing the $1/\sqrt{2}$ times of the peak value of sine wave and the preset current value. At the same time, RMS is calculated at 100ms based on the sampling data at every 3.3ms.

- Recording

When the preset current detection value is exceeded (Point A), the instrument records 8 data points including:

- 3 RMS values prior to the cross over point
- RMS value at the cross over point
- 4 RMS values subsequent to the cross over point.

The peak value when detecting is recorded with time information.

In case the event that exceeds the current detection value occurs continuously, current will not be detected until it drops to 50% or less of preset current value as the last detected leakage current is remaining.

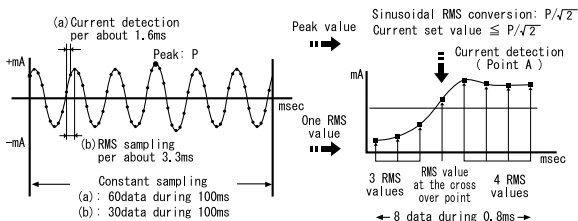

- Display of measured value

At measurement state before a recording, the max. measured value (RMS) at the selected channel is displayed on the LCD at every 1 sec..

(3) ↗ Max. value recording mode

- Current detection and RMS calculation

Sampling is performed consistently at 1.6ms intervals. Current is detected by comparing the $1/\sqrt{2}$ times of the peak value of sine wave and the preset current value. At the same time, RMS is calculated at 100ms based on the sampling data at every 3.3ms.

- Recording

When the preset current value is exceeded (Point A), the instrument starts recording and ends either when the value drops to below 50% of the set value, or after an elapse of 10min. During the recording period, the instrument records the max value reached every 10secs. In case the event that exceeds the preset current value occurs continuously, current will not be detected until it drops to 50% or less of preset current value as the last detected leakage current is remaining.

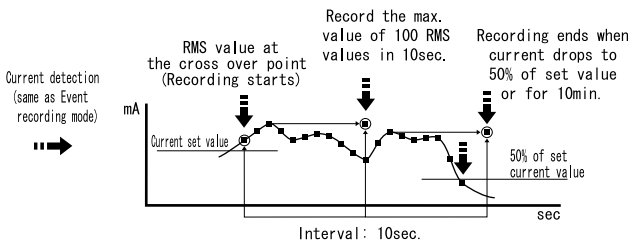

- Display of measured value

At measurement state before a recording, the max. measured value (RMS) at the selected channel is displayed on the LCD at every 1 sec.. The max. value is displayed on the LCD at every 10 sec. during a recording.

(4) \mathcal{N} Capture recording mode

- Current detection and RMS calculation

Sampling is performed consistently only at Channel 1 at 1.6ms intervals. Current is detected by comparing the $1/\sqrt{2}$ times of the peak value of sine wave and the preset current value.

- Recording

When the preset current detection value is exceeded (Point A), the instrument records instantaneous values with corresponding time information for 200ms (10 to 12 waveforms) including 50ms prior to and subsequent to the cross over point. In case the event that exceeds the current detection value occurs continuously, current will not be detected until it drops to 50% or less of preset current value as the last detected leakage current is remaining.

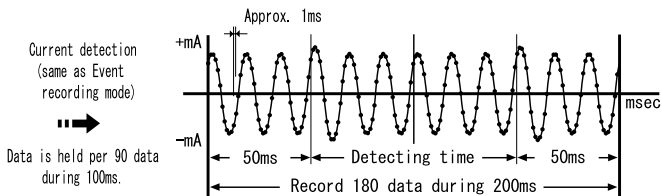





- Display of measured value

At measurement state before a recording, the max. measured value (RMS) at Channel 1 is displayed on the LCD at every 1 sec.. (* Waveform cannot be displayed on the LCD of the instrument. Transfer the data to PC by using PC software of accessory, and check the graphic display.)

7. Other settings (Setting2)

Menu Setting 2: "SEt.2" Setting items





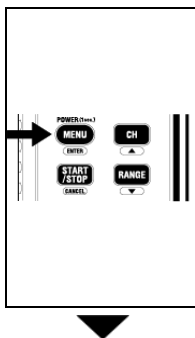



- 1) Location information
Set the location no. to identify the measuring and recording place.
- 2) Auto-power-off 
Enable/ Disable the Auto-power-off function.
- 3) Time 
Capable of adjusting the time within 00:00 to 23:59.
- 4) Timer  
Display and set the timer.
- 5) Scale **SCAL**
The value: measured value multiplied by scale value, is displayed on the LCD.

Setting procedure



1. Power on the instrument, and press the  button.

Then the instrument goes into Menu mode. Each button acts as follows at Menu mode.

- | | | | |
|---|---|---|------------------------------|
|  | → |  | : Select, Change, Enter |
|  | → |  | : Return, Cancel |
|  | → |  | : Switch, Increase set value |
|  | → |  | : Switch, Decrease set value |

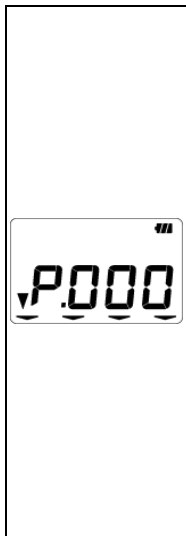
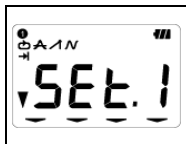

2. Press the **ENTER** button when "SEt.1" is displayed on the LCD.

3. Press the **ENTER** button when "SEt.2" is displayed on the LCD.

4. "Location information":

The location no. is displayed.

Can be selected between "P.000" and "P.999".

- Press the **▼** button and proceed to the next step (Auto-power-off) when not changing the setting.
- To change the setting, press the **ENTER** button.

Then the indication on the LCD flashes. Press the **▲** or **▼** button to set the value to the desired one. Then press the **ENTER** button to confirm it.

Note Location no. is linked to the location list in PC Software and allows to display the location name, which corresponding to the location no., when displaying data on PC software.

In case of setting it on the instrument, it is recommended to take notes of the location no. and the name.

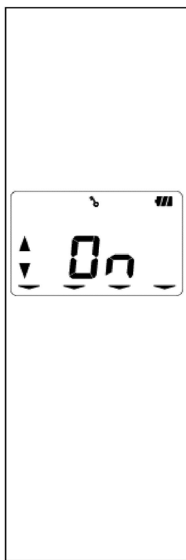





5. "Auto-power-off":

State of Auto-power-off function is displayed.

On : Enables Auto-power-off function.

OFF : Disables Auto-power-off function.



- Press the  button and proceed to the next step (Time) when not changing the setting.
- To change the setting, press the  button.



Then the indication on the LCD flashes. Press the  or  button to set the value to the desired one. Then press the  button to confirm it.

Note The  mark is displayed on the LCD when the Auto-power-off function is disabled. Be sure to power off the instrument after use. When it is enabled, instrument is powered off automatically when 3 min has been elapsed after the last operation of keys. During a recording, indications on the LCD disappear automatically for saving the battery life, however, a recording is being performed.

6. "Time": Time is displayed.

Can be adjusted within "00:00" to "23:59".

- Press the  button and proceed to the next step (Timer) when not changing the setting.
- To change the setting, press the  button.

Then the indication on the LCD flashes. Press the  or  button to set the value to the desired one. Then press the  button to confirm it.

Note Connect the instrument to PC and set time and date via PC software "KEW LOG Soft".

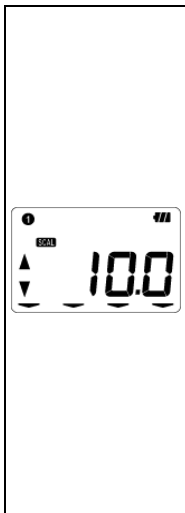
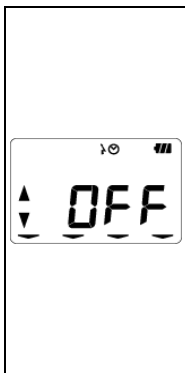

7. "Timer": State of Timer function is displayed.

Can be set within "00:00" to "23:59".

- Press the button and proceed to the next step (Scale) when not changing the setting.
- To change the setting, press the button.

Then the indication on the LCD flashes. Press the or button to set the value to the desired one. Then press the button to confirm it.

Note Press the "" button at least 1 sec. after setting. Then the instrument goes into stand-by mode for recording. Recording starts at the preset time.

8. "Scale": Scale value at Channel 1 is displayed.

Can be set within "0.1" to "10.0". (1.0: OFF)

- Press the button and proceed to the next step (Scale value at Channel 2) when not changing the setting.
- To change the setting, press the button. Then the indication on the LCD flashes. Press the or button to set the value to the desired one. Then press the button to confirm it.

Note When measuring one-tenth signal via Multi-tran or something, if the scale value is set to 10.0; measured value can be directly read from the LCD as it is displayed : Measured value x 10.0 = Indicated value. (It will not be reflected on the recorded data.)

* e.g.: Set "10.0" at CH 1. Then "150.0mA" is displayed as a measured value when measuring 15.0mA at CH 1.

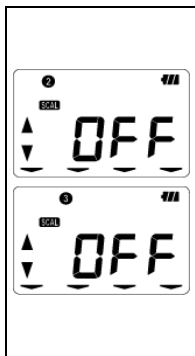

9. Scale value at Channel 2 is displayed.

- Press the button and proceed to the next step (Scale value at Channel 3) when not changing the setting
- To change the setting, press the button. (Refer to the procedure described for Channel 1.)

10. Scale value at Channel 3 is displayed.

- Press the button and proceed to the next step when not changing the setting.
- To change the setting, press the button. (Refer to the procedure described for Channel 1.)

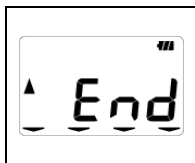

11. Now Setting 2 is complete; "End" is displayed on the LCD. Press the button to return to the screen on which "SEt.2" is displayed.



12. Press the button to get the instrument ready for a measurement.

8. Data transfer to PC

- Install PC software "KEW LOG Soft" on your PC before using the instrument. Please refer to the instruction manual for "KEW LOG Soft" which shows how to install the software.
(The instruction manual for "KEW LOG Soft" is contained in the supplied CD; or click "Start" → "Program" → "KEW" folder.)
- When connecting the logger to PC for the first time, your PC will recognize this new hardware and install the USB driver.
Follow the instructions described in the instruction manual for "KEW LOG Soft" and install it on your PC.

8-1 Connection of USB cable

- (1) Connect the USB cable to the available USB port of PC.

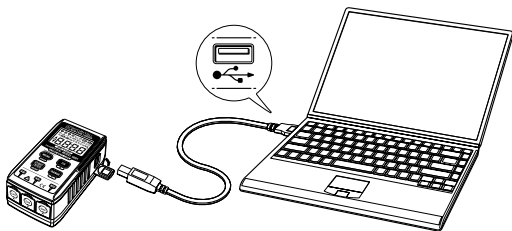

- (2) Connect the other end of USB cable to the USB terminal on the right side of this instrument.

Note:

Remove the protective cover of USB terminal carefully, and connect a cable to it. When the cover is damaged, it may cause poor contact due to dust, etc.

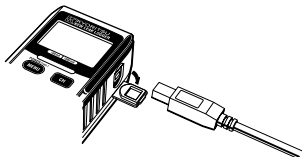

8-2 Preparation for data transmission

- (1) Power on the instrument, and get the instrument ready for a measurement.
(Note: Data cannot be transferred while the instrument is performing a recording.)
- (2) Start up the PC software: KEW LOG Soft.

8-3 Operation of PC software

Refer to the supplied instruction manual for "KEW LOG Soft" and transfer the data to your PC. The PC may not detect the connected Logger or error message is displayed during data transfer, even if the PC and the Logger are connected correctly because of static electricity.

In this case, a message is displayed on the PC screen. Please disconnect/ connect the USB cable once accordingly, and transfer the data again.

8-4 Multiple connections

By using commercially available USB hub, multiple Leak Loggers can be connected to your PC. With PC software "KEW LOG Soft", the data can be transferred to PC by selecting one Logger from the list of detected Logger.

You do not have to connect and disconnect a USB cable one by one.

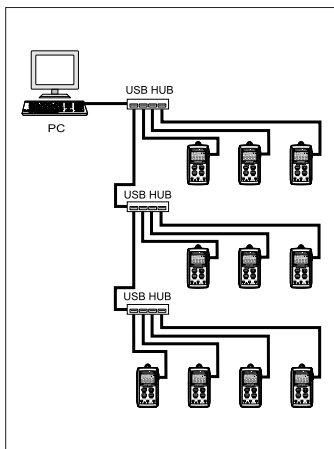



9. Battery replacement

WARNING

- In order to avoid electrical shock, remove sensors from the instrument when replacing batteries.

CAUTION

- Do not mix new and old batteries.
- Install batteries in the orientation as shown inside the battery compartment, observing correct polarity.

When only the leftmost segment of the Battery mark is flashing on the LCD  , it means battery voltage is low. Replace the batteries with new ones. There is no influence on the measurement accuracy even if this warning mark is flashing. Nothing even the Battery mark  is displayed on the LCD if the batteries are completely exhausted. Replace the batteries with new ones.

- (1) Loosen two Battery-cover fixing screws on the backside of the instrument and remove the cover.
- (2) Replace the batteries with new ones.
(Battery : Alkaline, LR6, 1.5V)
- (3) Install the Battery cover, and tighten up the screws.

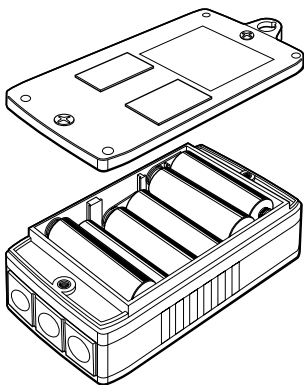

10. Specification

● Measuring Ranges and Accuracy

* Continuous recording mode [RMS] (50/60Hz, Sine wave)

Range	Measuring range	Accuracy of the instrument	Accuracy when combining with sensor
100mA	0~100.0mA	$\pm 1.0\%rdg \pm 5dgt$	$\pm 2.0\%rdg \pm 10dgt$
1000mA	0~1000mA		$\pm 2.0\%rdg \pm 6dgt$

Crest Factor ≤ 2.5 : Sine wave accuracy +2%+5dgt

* Event/Max. value/ Capture recording mode [RMS] (50/60Hz, Sine wave)

Range	Measuring range	Accuracy of the instrument	Accuracy when combining with sensor
100mA	0~100.0mA	$\pm 1.5\%rdg \pm 7dgt$	$\pm 2.5\%rdg \pm 12dgt$
1000mA	0~1000mA		$\pm 2.5\%rdg \pm 8dgt$

* Current detection (Event/ Max. value/ Capture recording mode):

* Capture recording mode [instantaneous value]:

Range	Measuring range	Accuracy of the instrument	Accuracy when combining with sensor
100mA	0~100.0mA	$\pm 3\%rdg \pm 2\%fs$	$\pm 4\%rdg \pm 2.5\%fs$
1000mA	0~1000mA		$\pm 4\%rdg \pm 2\%fs$

NOTE: Electromagnetic compatibility(EMC)

EN61000-4-2 Electrostatic discharge immunity(ESD)

Performance criteria: B

- Operating system : Successive Approximation
- Input : AC voltage(AC100mV/A)
- Rated max. working voltage : AC170mVrms, 250mV peak value
- Number of input channel : 3
- Measuring method : True RMS
- RMS Measuring interval :
 - Continuous recording mode:
 - approx. 1sec. to 60 min. depends on recording Interval.
 - (intermittent sampling)
 - Max. value, Event mode :
 - approx. 100ms. Normally, sampling at 3.3ms intervals. (Current detection: at the interval of about 1.6ms.)
 - Capture recording mode :
 - approx. 100ms. Consistently, sampling at 1ms intervals.
 - (Current detection: at the interval of about 0.5ms.)

- Display : Liquid crystal display
- Low battery warning : Battery mark display(in 4 levels)
- Overrange indication : "OL" mark appears when exceeding measuring range. (Max. indication 1049counts.)
- Auto power off : Power off function operates automatically after a switch remains for 3min. (when recording is stopped)
- Temperature & humidity range(guaranteed accuracy) :
23°C±5°C/Relative humidity 85% or less (no condensation)
- Operating temperature & humidity range :
0°C~50°C/Relative humidity 85% or less (no condensation)
- Storage temperature & humidity range :
-20°C~+60°C/Relative humidity 85% or less (no condensation)
- Battery : DC6V: Alkaline battery(LR6) x 4pcs (M5000)
DC9V: Alkaline battery(LR6) x 6pcs (M5001)
- Current consumption : approx. 5mA
- Possible measurement time :Approx.25days(M5000)/40days(M5001)
(At room temperature, until the instrument isnot powered on.)
- Applicable standards : IEC 61010-1:2001
CATIII 300V Pollution degree2
IEC 61326 (EMC standard)
Overload protection: AC 1500A MAX/ for 10sec. (when sensor M8143 is used.)
- Withstand voltage : AC3536V (RMS 50/60Hz)/ for 5sec.
- Insulation resistance : 50Mohm or more / 1000V
- Dimension : 111(H) x 60(W) x 36(D)mm (M5000)
111(H) x 60(W) x 42(D)mm (M5001)
- Weight : Approx.255g(M5000)/ 315g(M5001)
- Accessories : Alkaline battery LR6 x 4pcs (M5000)
Alkaline battery LR6 x 6pcs (M5001)
PC software for data display CD : 1pce
USB cable : 1pce.
Carrying case
Instruction manual, Quick manual
- Applicable clamp sensor : Leak clamp sensor (M8141/8142/8143)
- Option : Carrying Case (M9119)
Extension cord for sensor(M-7147)

MEMO

MEMO

DISTRIBUTOR

Kyoritsu reserves the rights to change specifications or designs described in this manual without notice and without obligations.



KYORITSU ELECTRICAL INSTRUMENTS WORKS, LTD.

No.5-20, Nakane 2-chome, Meguro-ku,
Tokyo, 152-0031 Japan

Phone : 81-3-3723-0131 Fax : 81-3-3723-0152

URL : <http://www.kew-ltd.co.jp>

E-mail : info@kew-ltd.co.jp

Factories : Uwajima & Ehime